

Leaf Lamp Series

Leaf Lamp Link Tree w Table

SL401-EN-V1



GREEN
FURNITURE
CONCEPT



Index

Modules	p3
Components Leaf Lamp Link Tree M w Table	p4
Components Leaf Lamp Link Tree L w Table	p5
Recycling of parts	p6
Parts Leaf Lamp Link Tree M w Table	p7-8
Assembly instructions Leaf Lamp Link Tree M w Table	p9-13
Parts Leaf Lamp Link Tree L w Table	p14-15
Assembly instructions Leaf Lamp Link Tree L w Table	p16-20
Parts Chargers for Leaf Lamp Link Tree w Table	p21
Assembly instructions Chargers for Leaf Lamp Link Tree w Table	p22

Leaf Lamp Link Tree M w Table

Medium sized metal construction with round table that can be connected to Seamless table. The table has a total diameter of 1000mm and the total diameter of the crown is 2300mm.



Leaf Lamp Link Tree L w Table

Large sized metal construction with round table that can be connected to Seamless table. The table has a total diameter of 1000mm and the total diameter of the crown is 3000mm.



Componets – Leaf Lamp Link Tree M w Table

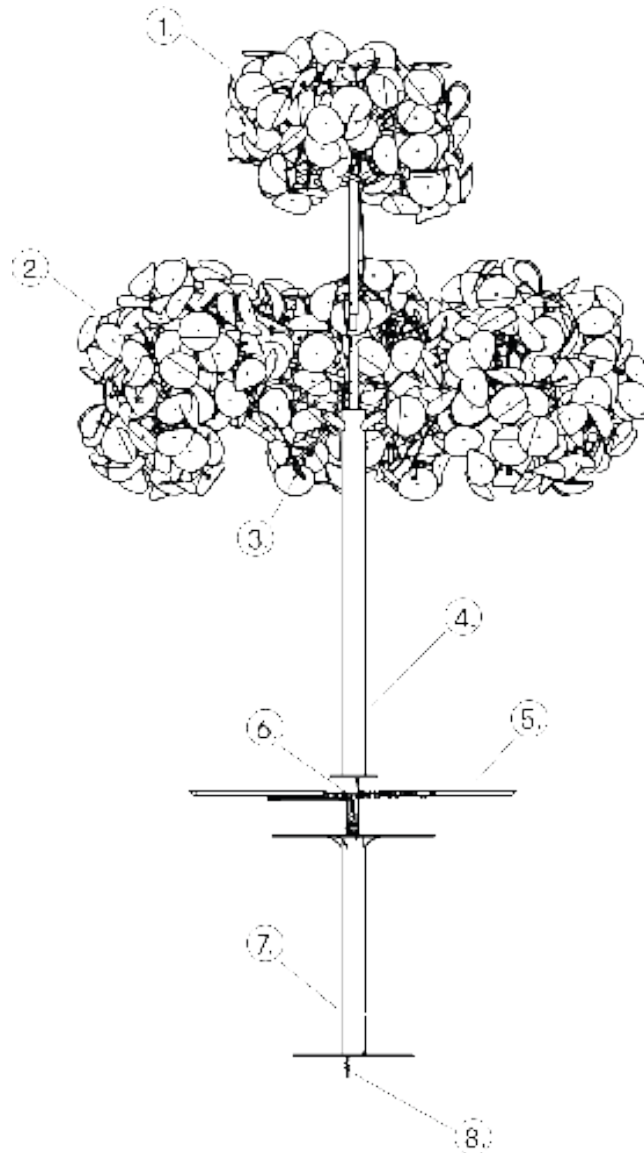

Numbers components

1. Leaf Lamp Metal Tree Cluster L 850 + 75
2. Leaf Lamp Metal Tree Cluster L 500 + 75
3. Leaf Lamp Link Tree Top Branch
4. Leaf Lamp Link Tree M Upper Trunk
5. Seamless Table Wood Top Endpiece w Hole
6. Connecting Armature CC 150
7. Leaf Lamp Link Tree Lower Trunk
8. Cable Kit for Leaf Lamp Link Tree M w Table

Componets – Leaf Lamp Link Tree L w Table

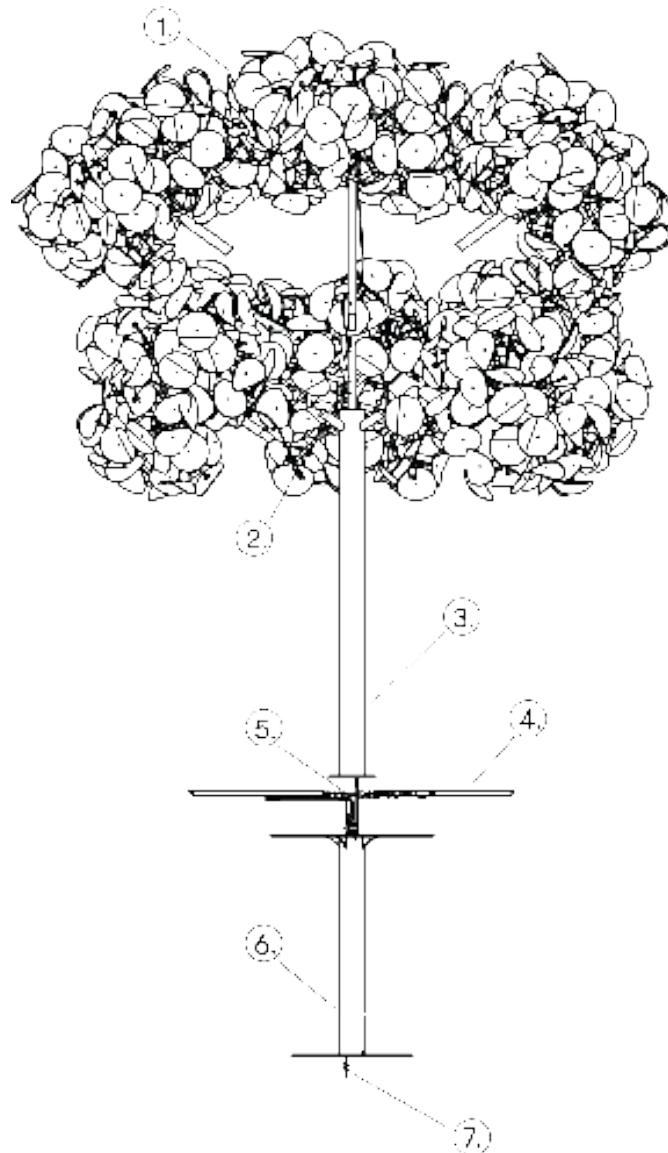

Numbers components

1. Leaf Lamp Metal Tree Cluster L 850 + 75
2. Leaf Lamp Link Tree Top Branch
3. Leaf Lamp Link Tree L Upper Trunk
4. Seamless Table Wood Top Endpiece w Hole
5. Connecting Armature CC 150
6. Leaf Lamp Link Tree Lower Trunk
7. Cable Kit for Leaf Lamp Link Tree L w Table

Recycling – Parts

Leaf Lamp Link Tree w Table

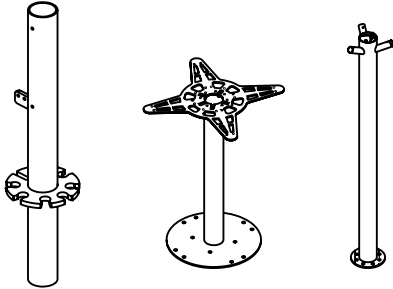

Steel parts

All metal parts such as the trunk, foot and top branch should be recycled as steel.

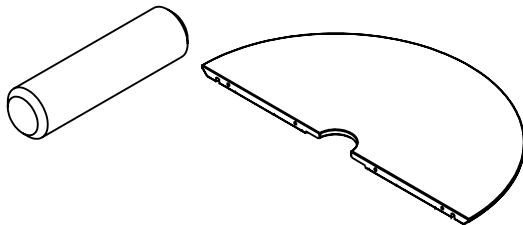

Wood parts

Wooden parts such as table tops and dowels should be separated and recycled as wood.

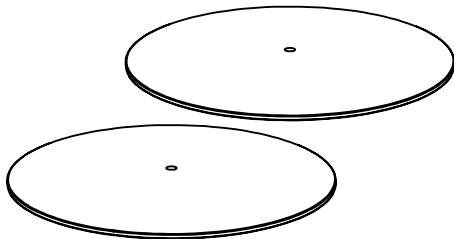

Textile parts

All felt leaves should be removed and recycled as textile waste.

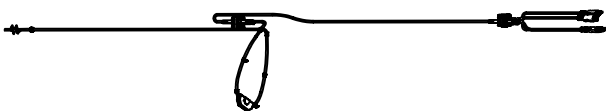



Electrical components

All electrical components such as cables, chargers and sockets should be separated and recycled as electronic waste.

Parts – Leaf Lamp Link Tree M w Table

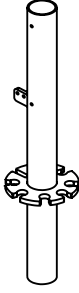
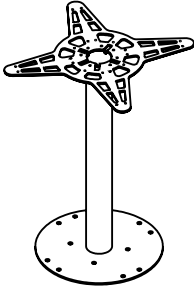
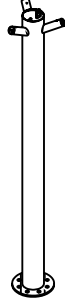
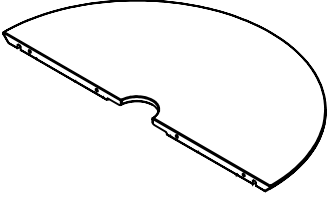

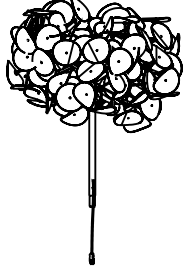
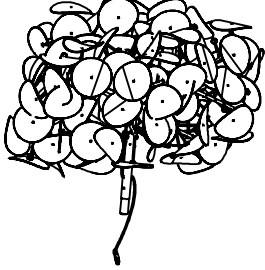
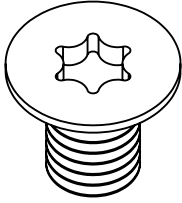
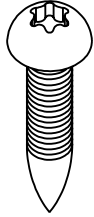
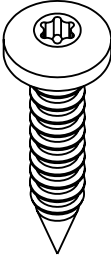
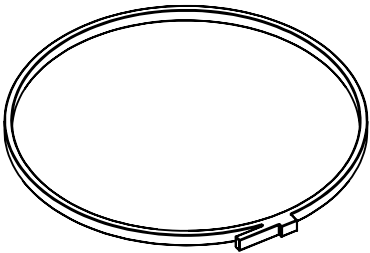
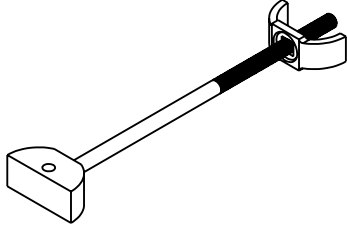
 <p>Leaf Lamp Link Tree Top Branch BA00062 x1</p>	 <p>Leaf Lamp Link Tree Lower Trunk BA00063 x1</p>	 <p>Leaf Lamp Link Tree M Upper Trunk BA00072 x1</p>
 <p>Seamless Table Wood Top Endpiece w Hole BP00127 x2</p>	 <p>Cable Kit for Leaf Lamp Link Tree M w Table EA00006 x1</p>	 <p>Leaf Lamp Metal Tree Cluster M 500 + 75 LLMT_C500 x3</p>
 <p>Leaf Lamp Metal Tree Cluster L 850 + 75 LLMT_C850 x1</p>	 <p>Countersunk Taptite Bolt Torx M5x8 SP003 x1</p>	 <p>Roundhead Wooden Screw Torx 3x16 SP042 x5</p>
 <p>Roundhead Wooden Screw Torx 5x30 SP071 x20</p>	 <p>Cable Tie L400 SP075 x2</p>	 <p>Connecting Armature CC150 SP076 x2</p>

Parts – Leaf Lamp Link Tree M w Table

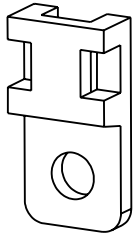

Cord Relief
SP090
x2

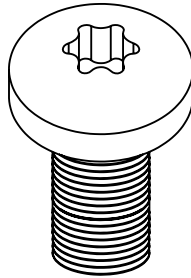

Roundhead Screw M5x10 Torx
SP137
x2

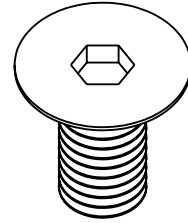

Countersunk Hexagon M8x16
TUFLOK SP138
x7

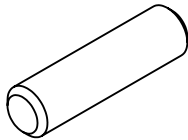

Wood Dowel 8x30
SP140
x4

Assembly Instructions – Leaf Lamp Link Tree w Table



Leaf Lamp Link Tree M w Table

1

NOTE: If your product is connected to a Baseplate Extension, start with reading separate manual for the Baseplate Extension.

2

Alt. 1
Power source
from floor

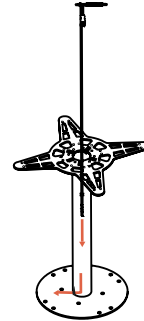

Start by pulling the starter cable through the lower trunk and through the side exit in the bottom. Make sure the grommet on the cable is secured in the trunk exit.

3

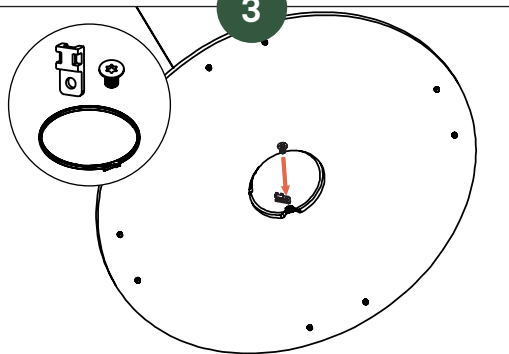

Attach the cord relief and the cable tie in the bottom of the lower trunk using the countersunk tap screw. **NOTE:** Attach the cord relief in the top if the power source is in the ceiling.

4

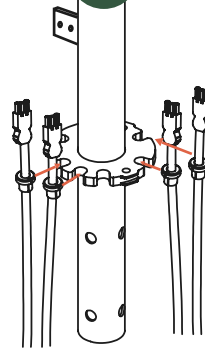

Place the two Y-coupler cables in the slots of the top branch. Make sure the grommets on the cables is secured in the slots.

5



Use the connection block to connect all Y-coupler cables to the interconnecting cable.

6

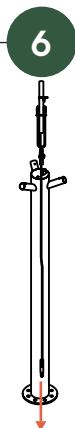

Take the upper branch with all connected cables and place in the top trunk. Pull the interconnecting cable through the whole trunk.

Assembly Instructions – Leaf Lamp Link Tree w Table



Leaf Lamp Link Tree M w Table

7

Alt. 2
Power source
from ceiling



Take the upper branch with all connected cables and the starter cable and place in the top trunk. Pull the interconnecting cable and starter through the whole trunk.

8

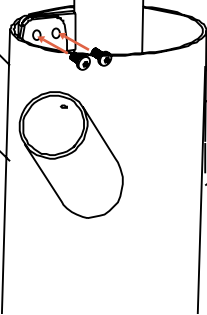

Roundhead
Screw M5x10
Torx
SP137

Attach the upper branch to the top trunk through the flange using the M5x10 screw.

9

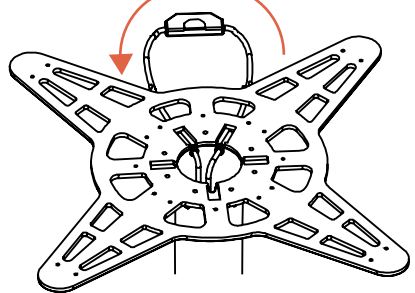

Make a loop of the starter cable and make sure that the thermal overload is on the outside of the trunk. Secure the cable with the grommets in the assigned slots of the trunk.

10

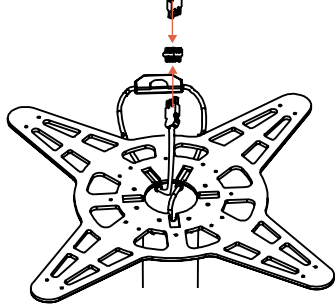

Use the connection block to connect the starter cable to the interconnection cable coming from the upper trunk. **NOTE:** If your product includes chargers, skip from here to page 22.

11

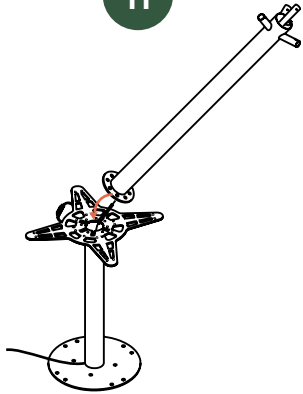

Take the whole upper trunk and place it on top of the lower trunk. Push the cables in to the lower trunk while doing this.

12

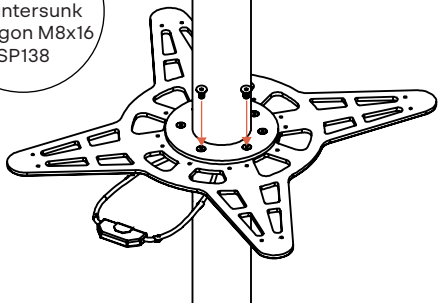

Countersunk
Hexagon M8x16
SP138

Attach the upper trunk to the lower trunk using the countersunk M8x16 screw in all seven holes in the disk.

Assembly Instructions – Leaf Lamp Link Tree w Table



Leaf Lamp Link Tree M w Table

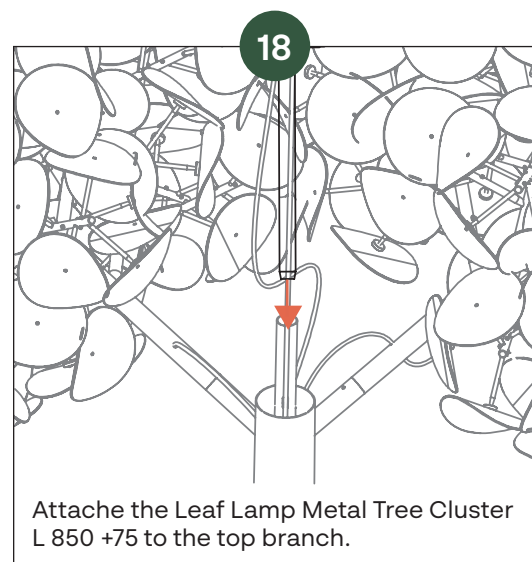
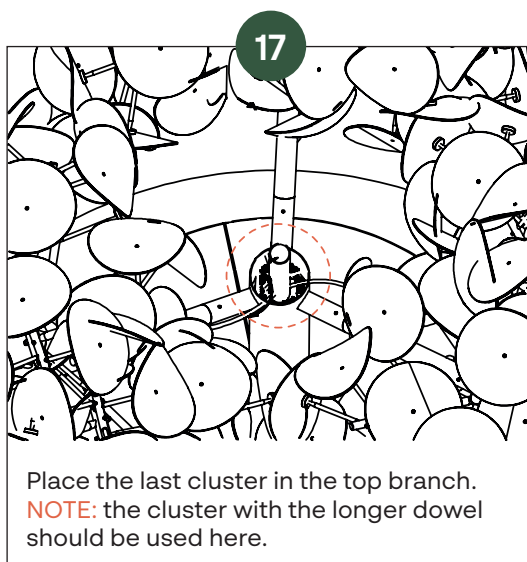
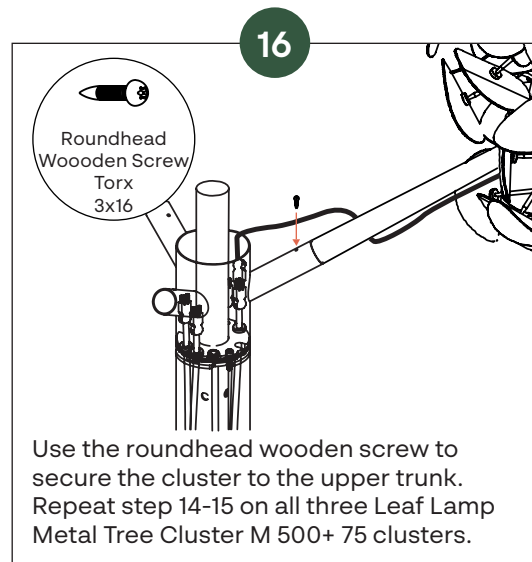
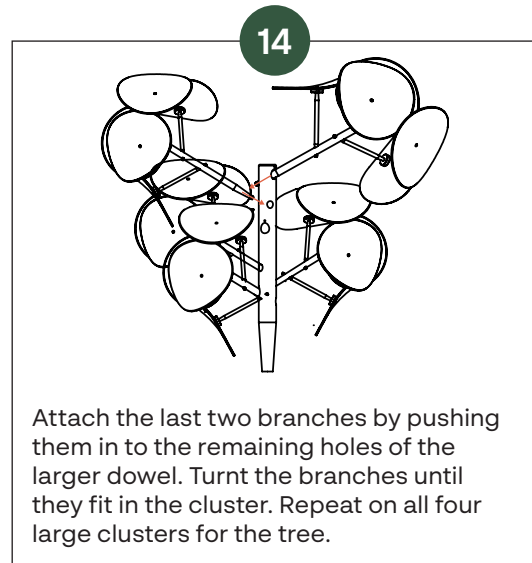
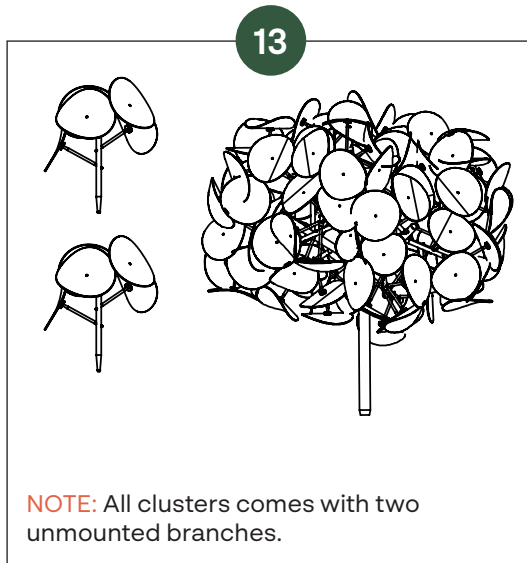

Assembly Instructions – Leaf Lamp Link Tree w Table



Leaf Lamp Link Tree M w Table

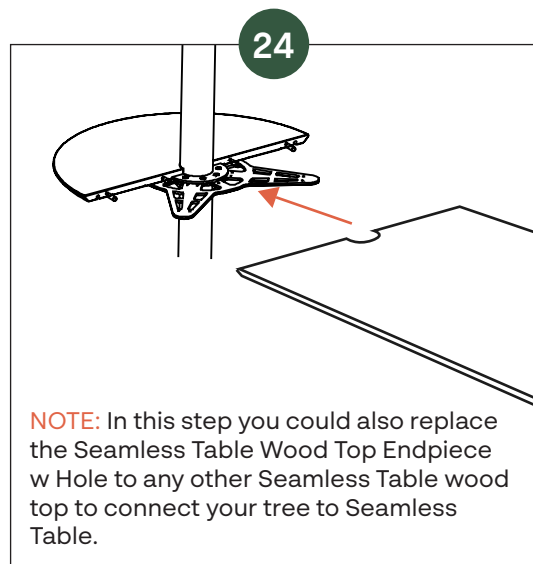
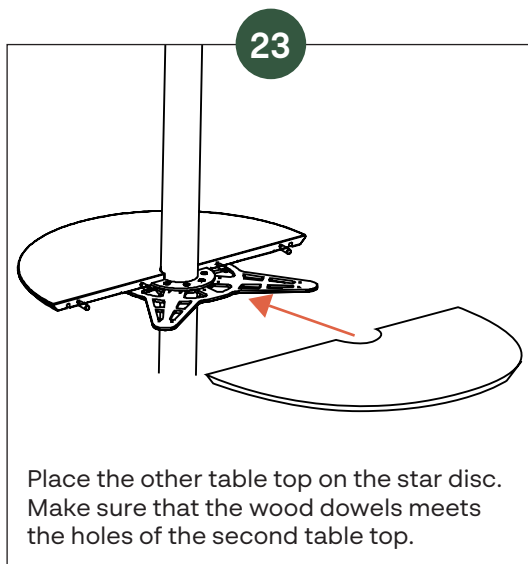
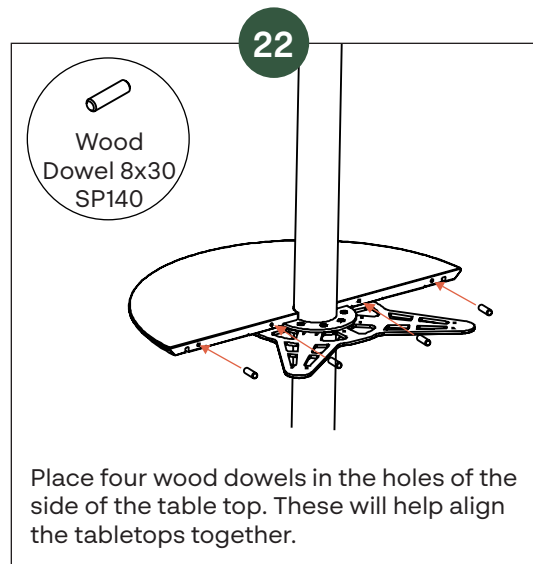
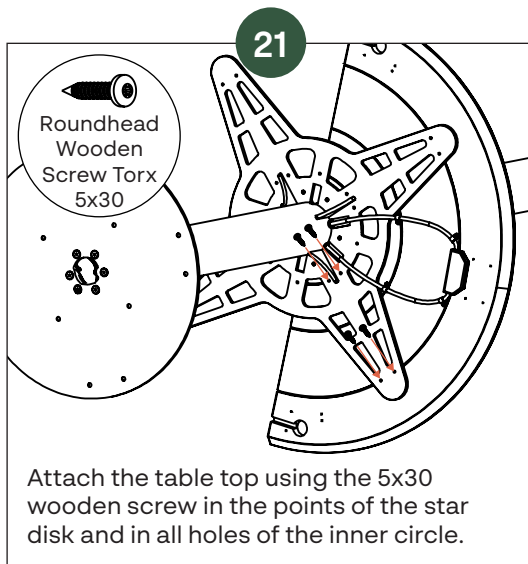
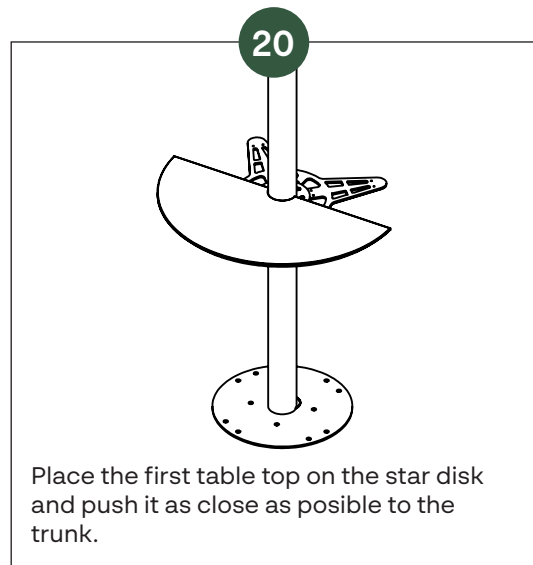
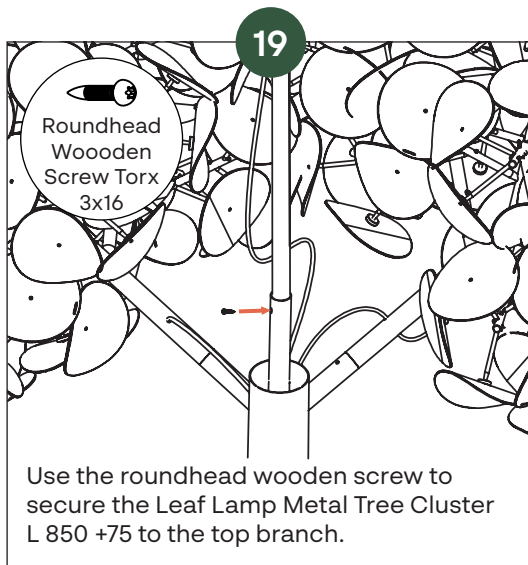

Assembly Instructions – Leaf Lamp Link Tree w Table



Leaf Lamp Link Tree M w Table

25

Roundhead
Wooden
Screw Torx
5x30

Attach the second table top using the 5x30 wooden screw in the points of the star disk and in all holes of the inner circle.

26

Place the connecting armature in the assigned slots under the table tops. Repeat with the second connecting armature on the other side.

27

To tighten the connection armatures and close the gap between the table tops, use an allen key. **NOTE:** Allen key not included.

28



Finished product assembly with power source from floor.

29

Finished product assembly with power source from ceiling.

Parts – Leaf Lamp Link Tree L w Table

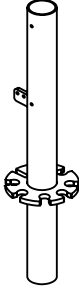
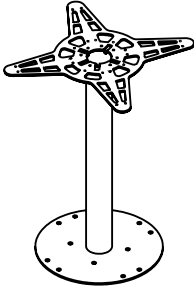
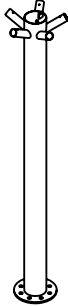
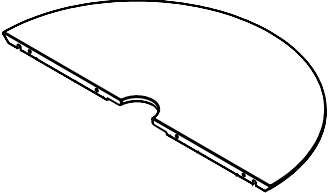

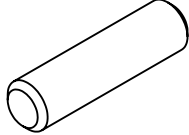
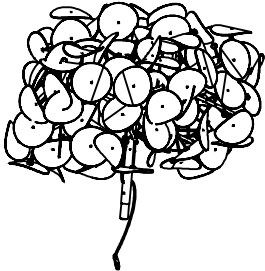
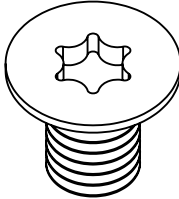
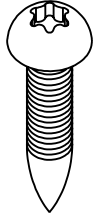
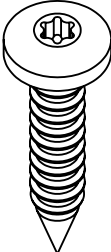
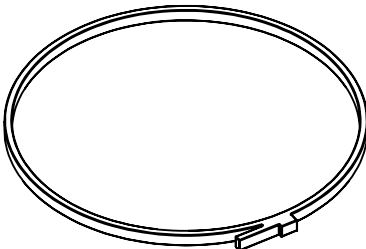
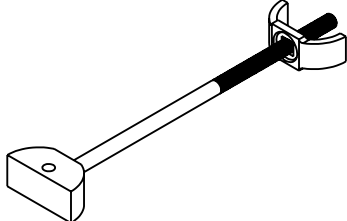
 <p>Leaf Lamp Link Tree Top Branch BA00062 x1</p>	 <p>Leaf Lamp Link Tree Lower Trunk BA00063 x1</p>	 <p>Leaf Lamp Link Tree L Upper Trunk BA00072 x1</p>
 <p>Seamless Table Wood Top Endpiece w Hole BP00127 x2</p>	 <p>Cable Kit for Leaf Lamp Link Tree L w Table EA00008 x1</p>	 <p>Wood Dowel 8x30 SP140 x4</p>
 <p>Leaf Lamp Metal Tree Cluster L 850 + 75 LLMT_C850 X6</p>	 <p>Countersunk Taptite Bolt Torx M5x8 SP003 x1</p>	 <p>Roundhead Wooden Screw Torx 3x16 SP042 x7</p>
 <p>Roundhead Wooden Screw Torx 5x30 SP071 x20</p>	 <p>Cable Tie L400 SP075 x2</p>	 <p>Connecting Armature CC150 SP076 x2</p>

Parts – Leaf Lamp Link Tree L w Table

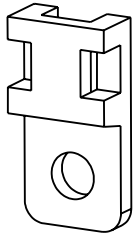

Cord Relief
SP090
x2

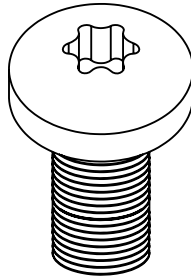

Roundhead Screw M5x10 Torx
SP137
x2

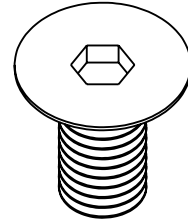

Countersunk Hexagon M8x16
TUFLOK SP138
x7

Assembly Instructions – Leaf Lamp Link Tree w Table



Leaf Lamp Link Tree L w Table

1

NOTE: If your product is connected to a Baseplate Extension, start with reading separate manual for the Baseplate Extension.

2

Alt. 1
Power source
from floor

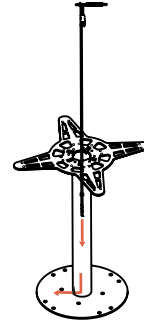

Start by pulling the starter cable through the lower trunk and through the side exit in the bottom. Make sure the grommet on the cable is secured in the trunk exit.

3

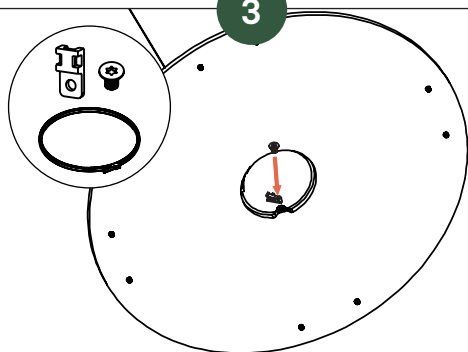

Attach the cord relief and the cable tie in the bottom of the lower trunk using the countersunk tap screw. **NOTE:** Attach the cord relief in the top if the power source is in the ceiling.

4

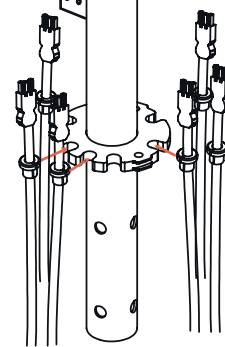

Place the three Y-coupler cables in the slots of the top branch. Make sure the grommets on the cables is secured in the slots.

5

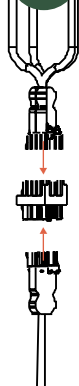

Use the connection block to connect all Y-coupler cables to the interconnecting cable.

6

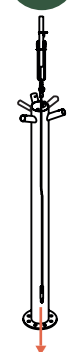

Take the upper branch with all connected cables and place in the top trunk. Pull the interconnecting cable through the whole trunk.

Assembly Instructions – Leaf Lamp Link Tree w Table



Leaf Lamp Link Tree L w Table

7

Alt. 2
Power source
from ceiling



Take the upper branch with all connected cables and the starter cable and place in the top trunk. Pull the interconnecting cable and starter through the whole trunk.

8

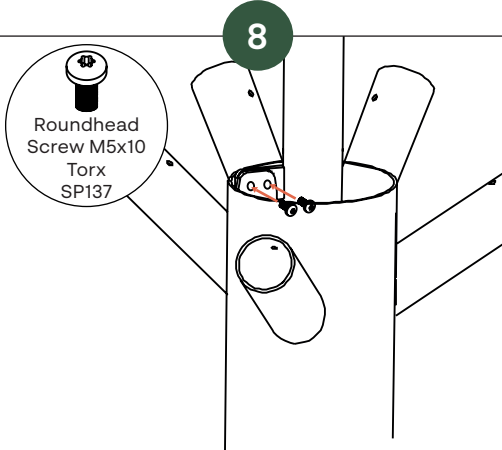

Roundhead
Screw M5x10
Torx
SP137

Attach the upper branch to the top trunk through the flange using the M5x10 screw.

9

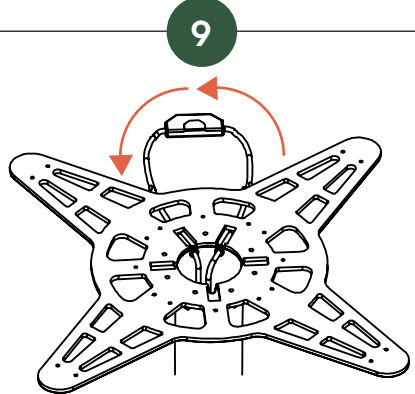

Make a loop of the starter cable and make sure that the thermal overload is on the outside of the trunk. Secure the cable with the grommets in the assigned slots of the trunk.

10

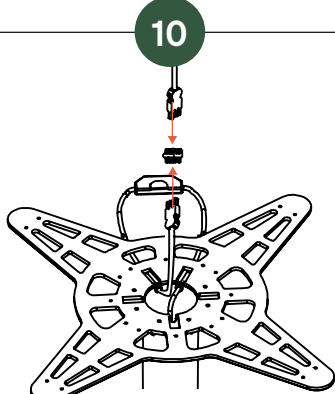

Use the connection block to connect the starter cable to the interconnection cable coming from the upper trunk. **NOTE:** If your product includes chargers, skip from here to page 22.

11

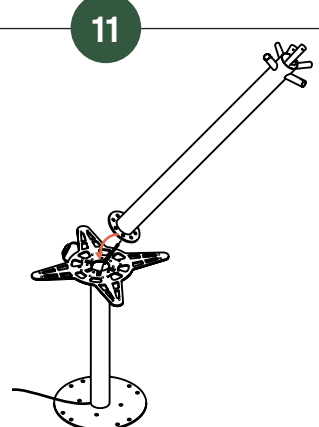

Take the whole upper trunk and place it on top of the lower trunk. Push the cables in to the lower trunk while doing this.

12

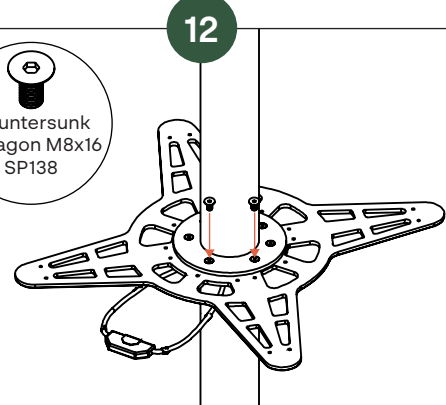

Countersunk
Hexagon M8x16
SP138

Attach the upper trunk to the lower trunk using the countersunk M8x16 screw in all seven holes in the disk.

Assembly Instructions – Leaf Lamp Link Tree w Table



Leaf Lamp Link Tree L w Table

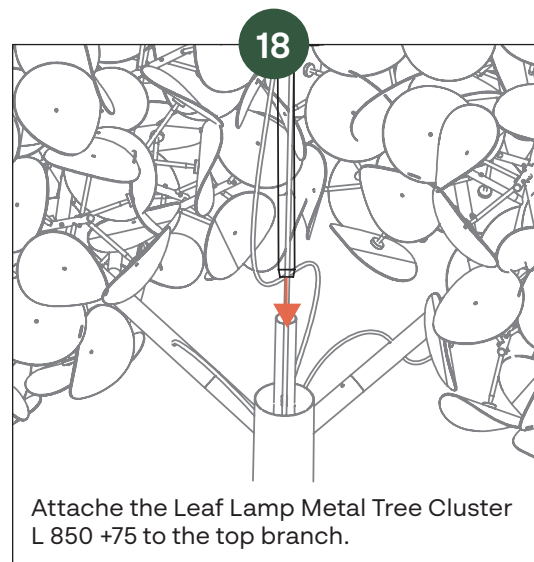
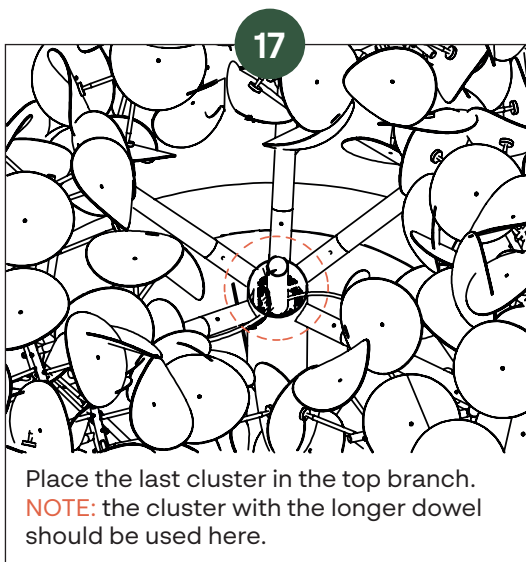
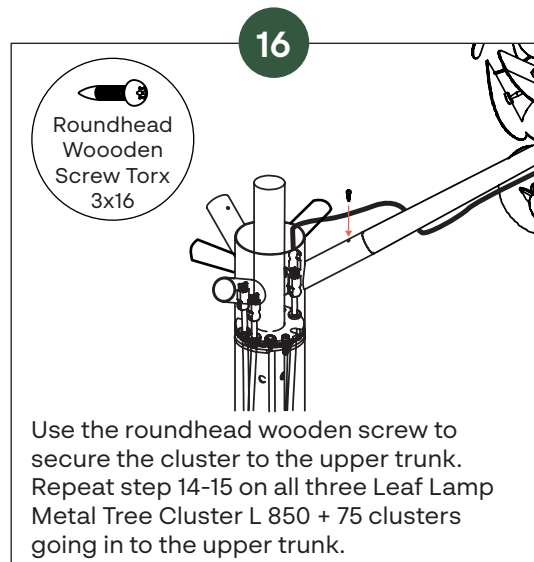
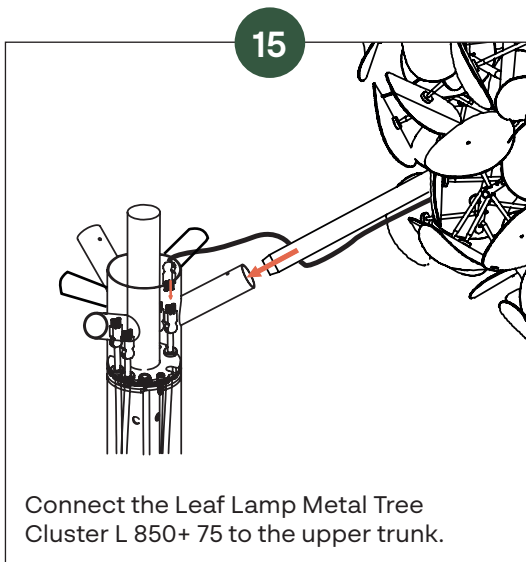
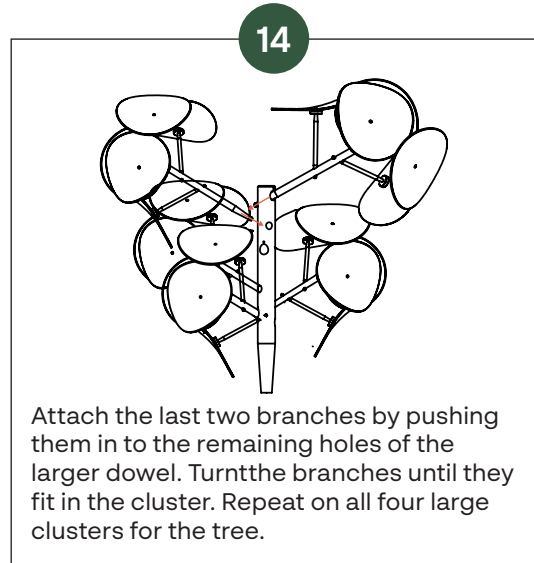
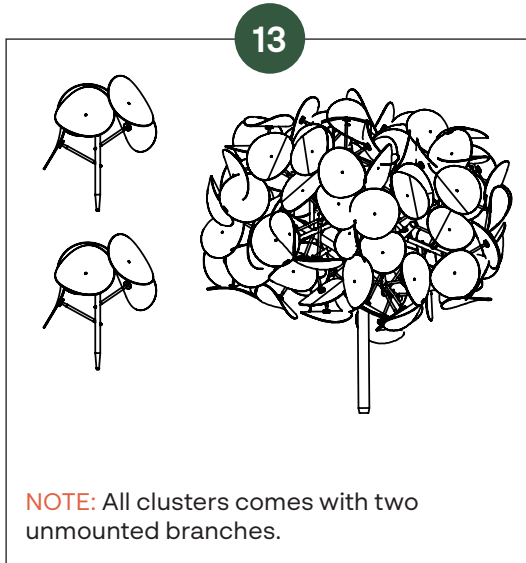

Assembly Instructions – Leaf Lamp Link Tree w Table



Leaf Lamp Link Tree L w Table

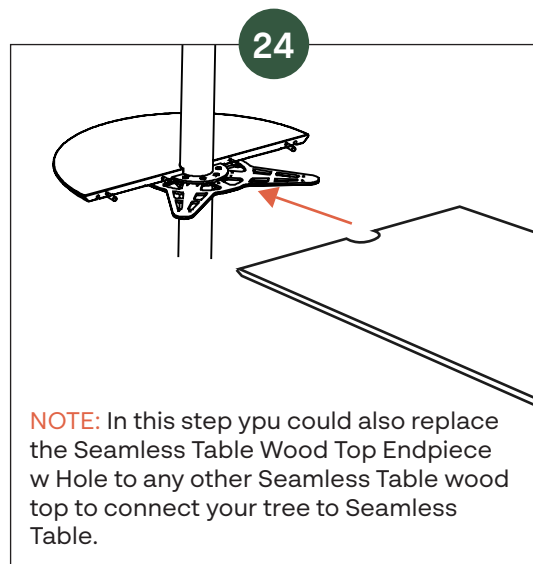
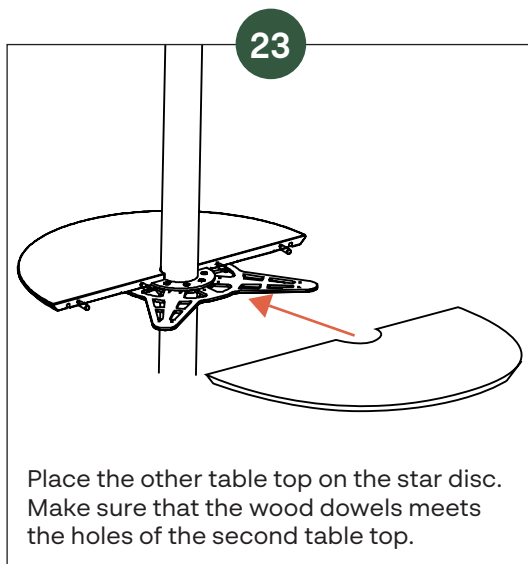
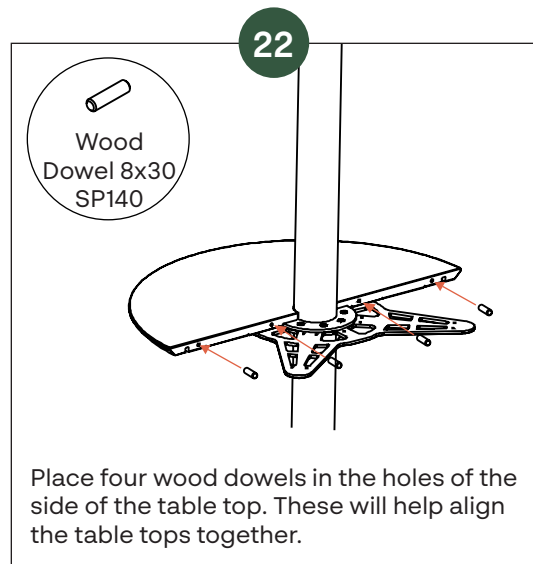
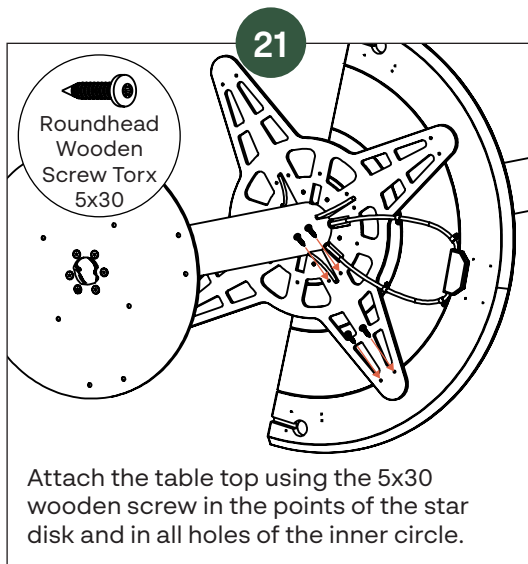
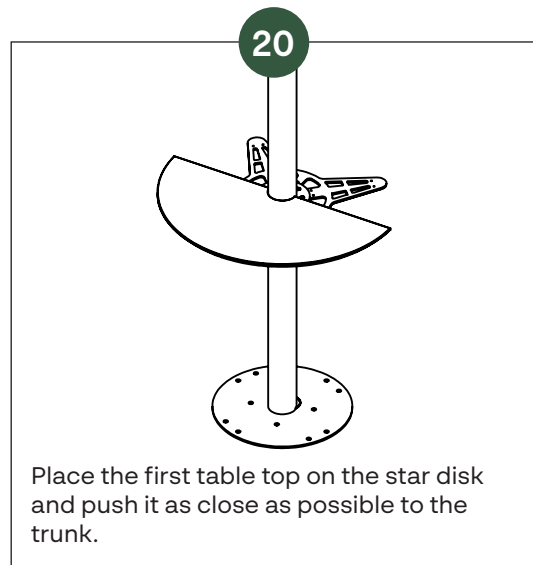
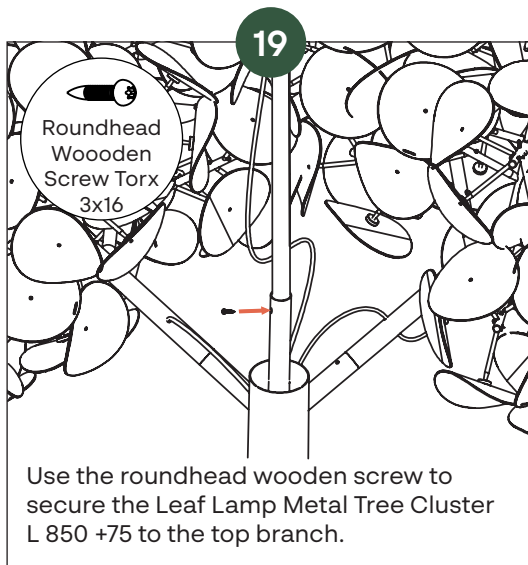

Assembly Instructions – Leaf Lamp Link Tree w Table



Leaf Lamp Link Tree L w Table

25

Roundhead
Wooden
Screw Torx
5x30

Attach the second table top using the 5x30 wooden screw in the points of the star disk and in all holes of the inner circle.

26

Place the connecting armature in the assigned slots under the table tops. Repeat with the second connecting armature on the other side.

27

To tighten the connection armatures and close the gap between the table tops, use an Allen key. **NOTE:** Allen key not included.

28

Finished product assembly with power source from floor.



29

Finished product assembly with power source from ceiling.

Parts – Chargers for Leaf Lamp Link Tree w Table

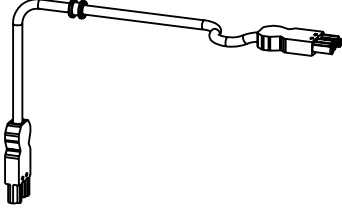
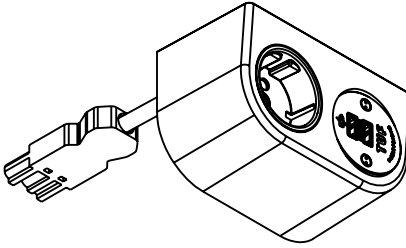
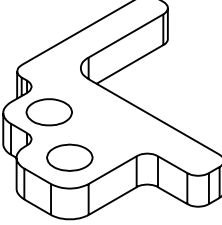
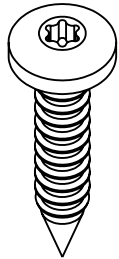

Leaf Lamp Link Tree M & L

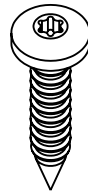
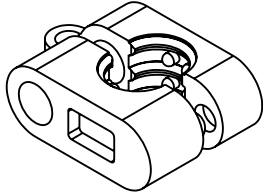
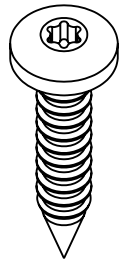
 <p>Interconnecting cable 500 mm EC083 x2</p>	 <p>Phase Charger 120 mm EC082 x2</p>	 <p>Bracket for Phase BP00093 x4</p>
 <p>Roundhead wooden screw 5x25 SP002 x4</p>	 <p>Cable Clip SP108 x4</p>	 <p>Roundhead Wooden Screw Torx 5x16 SP116 x4</p>
 <p>Cord Relief Clamp SP143 x4</p>	 <p>Roundhead wooden screw 5x35 SP146 x4</p>	

Assembly Instructions – Chargers for Leaf Lamp Link Tree w Table

1

For assembly of chargers to Leaf Lamp Link Tree w Table, start the assembly when you are on step 10 in the assembly of your tree.

2

Connect the two interconnecting cables for chargers to the connector block where the starter cable and the other interconnecting cable is plugged in.

3

Thread the interconnection cables out to the sides of the trunk, making sure that the grommets are secured in the assigned slots. Push the connector block and the cables down in the trunk.

4

Connect the phase chargers to the interconnecting cables. **NOTE:** the next following steps needs to be done after completing the assembly of your tree.

5

Use the screws that are included in the phase charger to attach the plastic plate to the table tops. Repeat on both sides.

6

Slide the phase charger on to the plastic plate until it clicks in place. Repeat on both chargers.

Assembly Instructions – Chargers for Leaf Lamp Link Tree w Table

