

Accessories

Nova C Divider

Space dividers attached to the Nova C Back modular seating. Seamless, and with curvature of choice just like the seating. The Nova C divider comes with cut out holes for a see-through effect (custom patterns possible) or plain which gives a surface where a message or image can be applied.

Sustainability Information

- Metal parts: powder coating with zero chemicals on the SIN-list
- Swedish production, following strict regulations on human rights, work environment, and anti-corruption
- The products need minimum maintenance
- At the end of their life, the products can be easily recycled. None needs to be disassembled

Variations

- Nova C Divider 100
- Nova C Divider Convex 45°
- Nova C Divider Concave 45°

Warranty

5 year warranty. At the end of the lifecycle, all parts can be separated to material level and recycled.

Materials & Finishes

The dividers are made of steel and powder coated. The colours have zero chemicals on the SIN-list. We can provide almost any RAL colour for the metal parts.

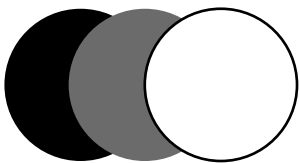

Standard Colours

Accessories

Nova C Divider

Maintenance & Cleanability

The maintenance for metal parts only consists of cleaning. The cleaning can easily be done by whipping surfaces of with water and a cloth.

Sizes & Measurements

The Nova C Divider comes in different sizes and curvatures.

Name: Nova C Divider 100

Article Number: A01E_3

Weight: 10,3 kg

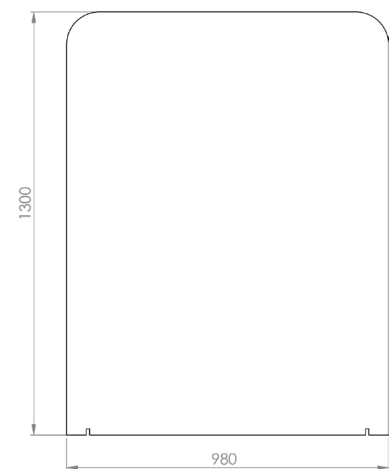
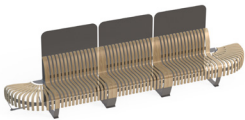

Name: Nova C Divider Convex 45°

Article Number: A01E_1

Weight: 7,6 kg

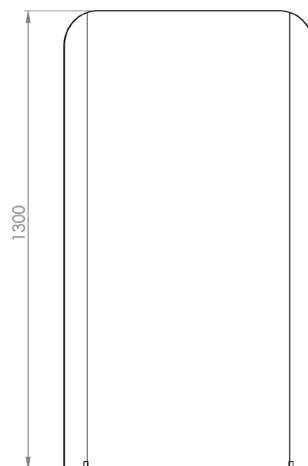
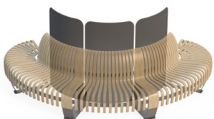

Name: Nova C Divider Concave 45°

Article Number: A01E_2

Weight: 13 kg

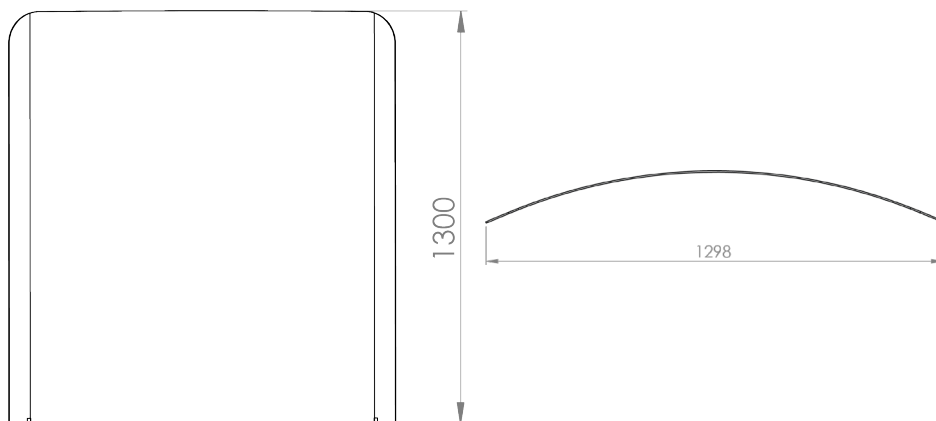
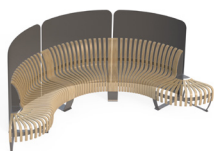

**GREEN
FURNITURE
CONCEPT**

GLOBAL

Carlsgatan 3
211 20 Malmö, Sweden
+46 (0)40 600 93 30

AMERICAS

15 Main St #244
Watertown MA, 02472 USA
Toll Free: 1 (877) 582-8664