



Accessories

Planter Divider

Planters that fit with the Green Furniture seating or connect modularly to form a curved, friendly wall of indoor and outdoor plants. Seamless and with the curvature of choice, just like the seating. The solid metal accessories are designed with the Green Furniture Concept seating series Nova C and Ascent in mind and work very well as stand-alone products.

Warranty

5 year warranty. At the end of the lifecycle, all parts can be separated to material level and recycled.

Sustainability Information

- Metal parts: powder coating with zero chemicals on the SIN-list
- Swedish production, following strict regulations on human rights, work environment, and anti-corruption
- The products need minimum maintenance
- At the end of their life, the products can be easily recycled. None needs to be disassembled

Variations

- Planter Divider Straight
- Planter Divider Convex
- Planter Divider Concave
- Planter Divider Donut
- Planter Divider Circle
- Planter Divider Corner
- Planter Divider Crossroad 3 Small
- Planter Divider Crossroad 4 Small
- Planter Divider Droplet
- Planter Divider Half Eye
- Planter Divider Eye
- Planter Divider T-Connection

Materials & Finishes

The dividers are made of steel and powder coated. The colours have zero chemicals on the SIN-list. We can provide almost any RAL colour for the metal parts.

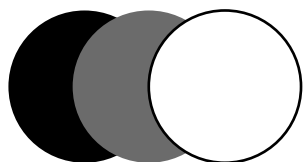

Standard Colours

Accessories

Planter Divider

Maintenance & Cleanability

The maintenance for metal parts only consists of cleaning. The cleaning can easily be done by whipping surfaces of with water and a cloth.

Sizes & Measurements

The Planter Divider comes in different sizes and shapes.

Name:

Planter Divider Straight

Article Number:

A01B_3

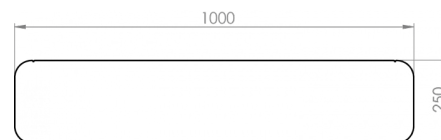
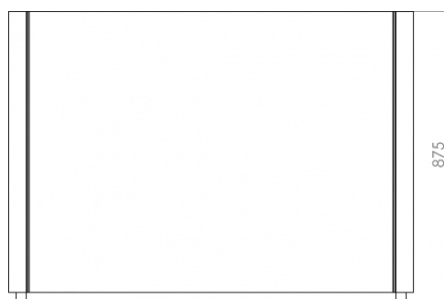

Name:

Planter Divider Convex

Article Number:

A01B_1

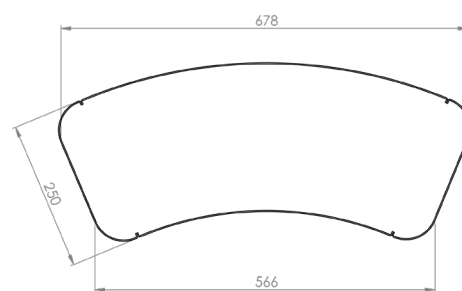
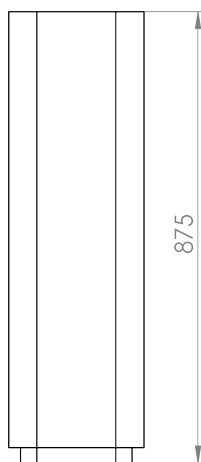
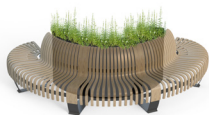

Name:

Planter Divider Concave

Article Number:

A01B_2

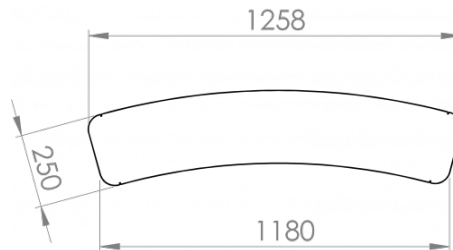
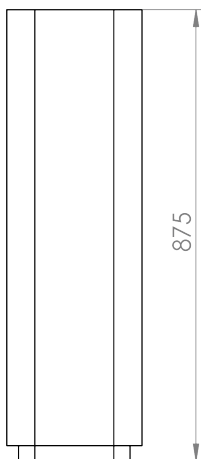

Name:

Planter Divider Donut

Article Number:

A01B_12

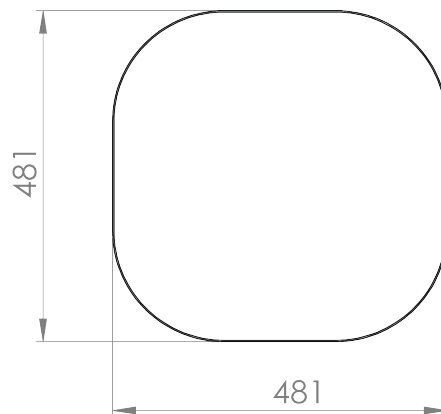
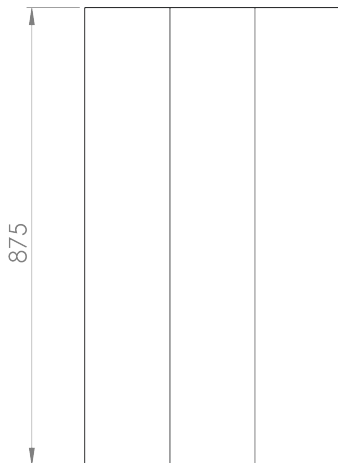

Name:

Planter Divider Circle

Article Number:

A01B_15

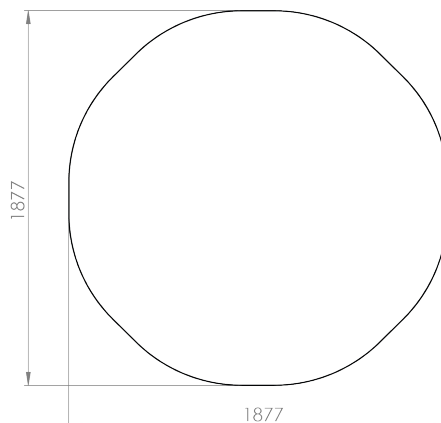
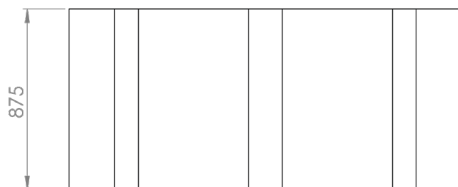
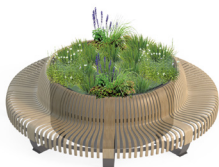

Name:

Planter Divider Corner

Article Number:

A01B_10

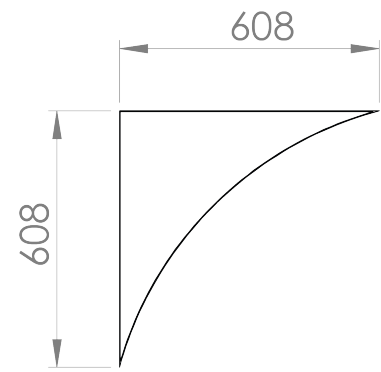
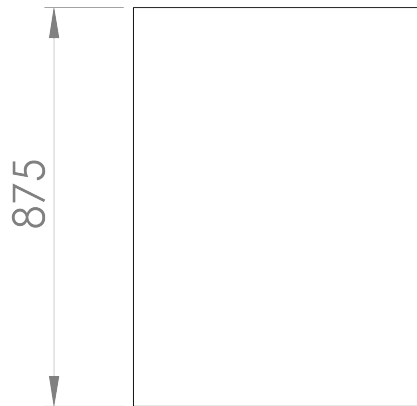

Name:

Planter Divider Crossroad 3 Small

Article Number:

A01B_14

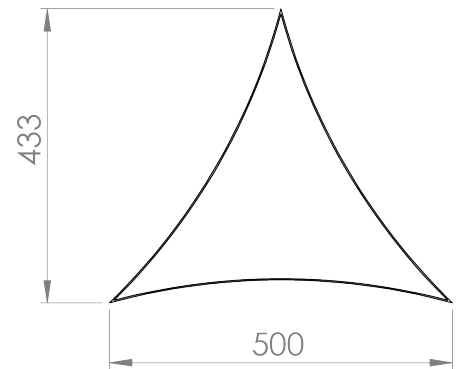
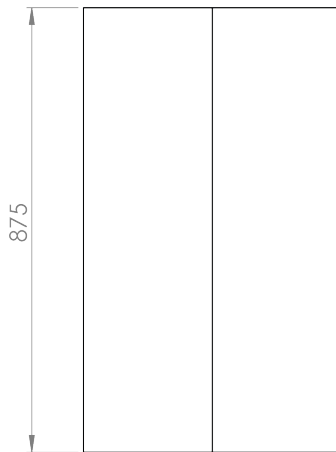

Name:

Planter Divider Crossroad 4 Small

Article Number:

A01B_13

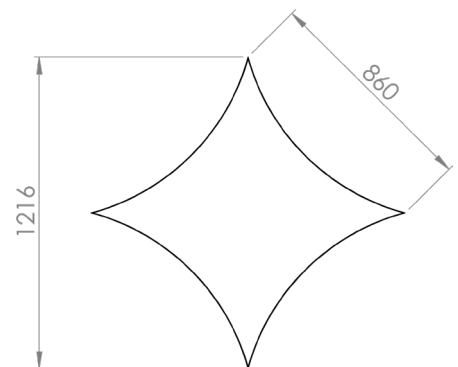
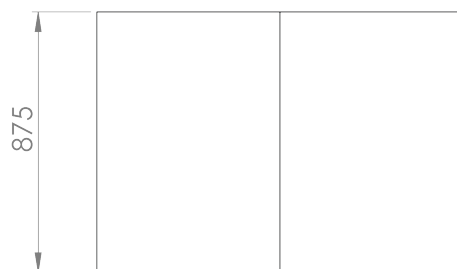

Name:

Planter Divider Droplet

Article Number:

A01B_11

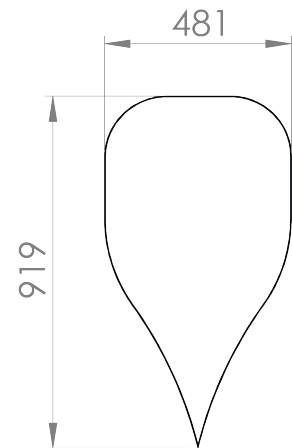
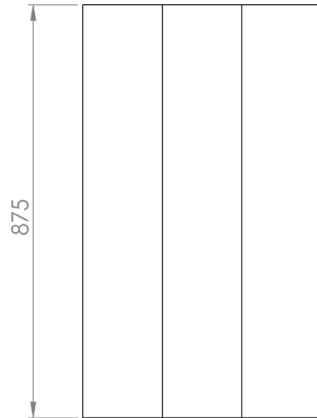

Name:

Planter Divider Half Eye

Article Number:

A01B_17

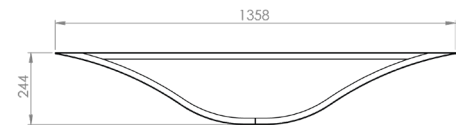
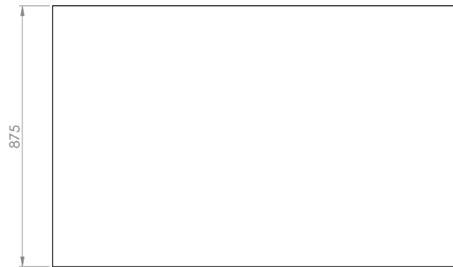

Name:

Planter Divider Eye

Article Number:

A01B_16

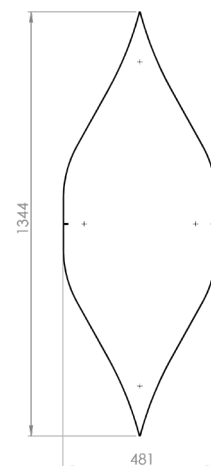
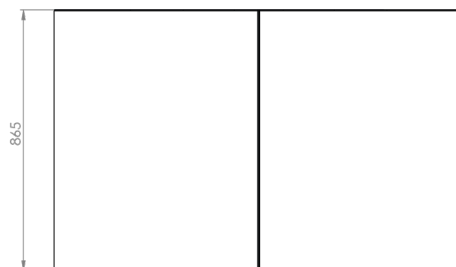

Name:

Planter Divider T-Connection

Article Number:

A01B_18

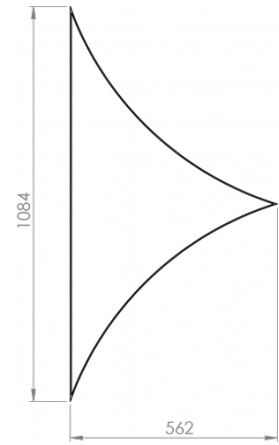
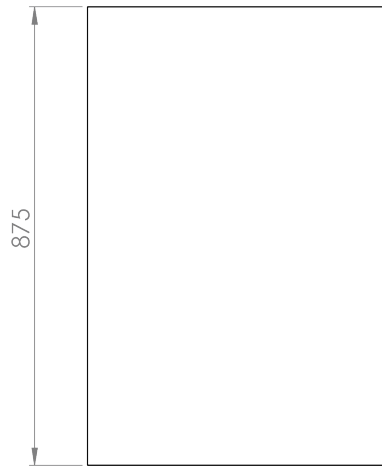

**GREEN
FURNITURE
CONCEPT**

GLOBAL

Carlsgatan 3
211 20 Malmö, Sweden
+46 (0)40 600 93 30

AMERICAS

15 Main St #244
Watertown MA, 02472 USA
Toll Free: 1 (877) 582-8664