

Leaf Lamp Series

# Leaf Lamp Tree M Manual

LL302-EN-V01



GREEN  
FURNITURE  
CONCEPT



## Index

Modules	p3
Recycling of parts	p4
Parts    Leaf Lamp Tree M	p5-6
Assembly instructions    Leaf Lamp Tree M	p7-9



# Leaf Lamp Tree M

Leaf Lamp Series

## Leaf Lamp Tree M

Cord: 230 V white textile cord Cord length: 7 m  
Trunk: around Ø150 mm, will vary at different heights of the trunk The cord is either guided to an electrical outlet in the ceiling, or on the inside of the trunk to an electrical outlet in the ground. This Leaf Lamp Tree comes with a little birdhouse attached to the trunk at assembly and hides all electrical components inside.



# Recycling – Parts

Leaf Lamp Series

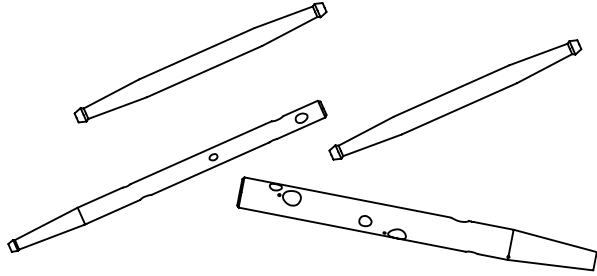

## Wood parts

Wooden parts such as the dowels should be separated and recycled as wood.

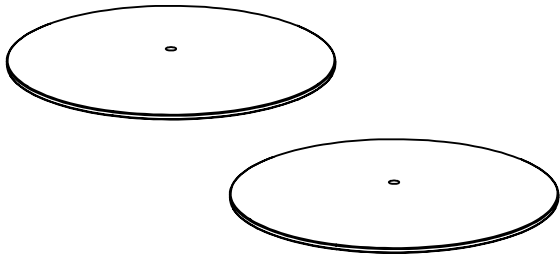

## Textile parts

All felt leaves should be removed and recycled as textile waste.

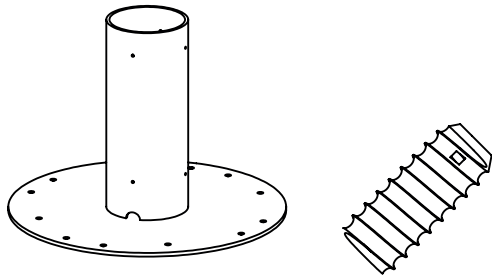

## Steel parts

All metal parts such as the foot and small parts should be recycled as steel.





## Electrical components

All electrical components such as cables, chargers and sockets should be separated and recycled as electronic waste.

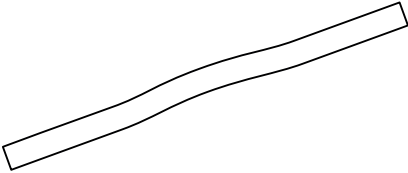
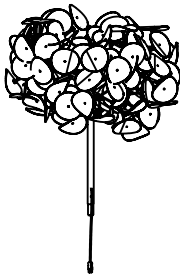
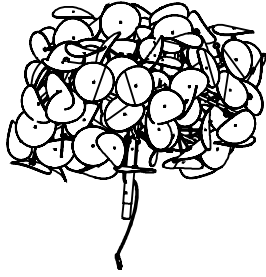
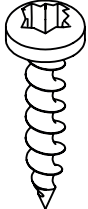
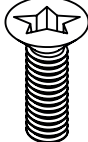
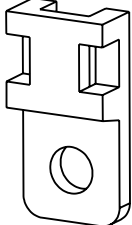
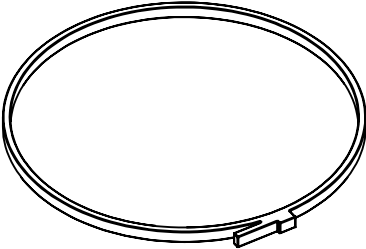
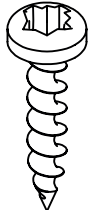
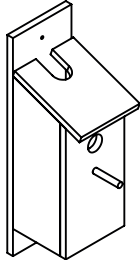

# Parts – Leaf Lamp Tree M

Leaf Lamp Series

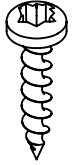
 <p>LL Trunk M LL0010 x1</p>	 <p>Cluster L 700 x1</p>	 <p>Cluster L 500 x3</p>
 <p>Roundhead wooden screw 4,5x70 SP063 x4</p>	 <p>Countersunk Taptite Bolt Torx M5x8 SP003 x1</p>	 <p>Cord Relief SP090 x1</p>
 <p>Cable Tie L400 SP075 x1</p>	 <p>Roundhead Wooden Screw 4,5x40 (torx) SP068 x2</p>	 <p>Birdhouse LL0019 x1</p>
 <p>Fastener Set Screw 6x20 SP061 x8</p>	 <p>Grommet 11,1x6,4x9,5 SP095 x1</p>	 <p>Roundhead wooden screw 3x16 SP042 x21</p>



# Parts – Leaf Lamp Tree M

Leaf Lamp Series

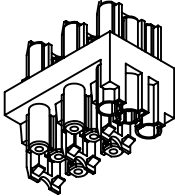
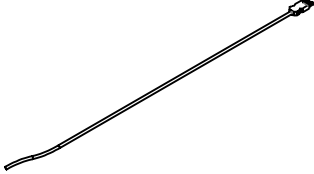
 <p>Distributor EC008 x1</p>	 <p>Cabel 7000 EC013D x1</p>
---	---

# Assembly Instructions – Leaf Lamp Tree M

Leaf Lamp Series

**1**

**NOTE:** If your product is connected to a Baseplate Extension, start with reading separate manual for the Baseplate Extension.

stext  
xxxxxxx

**2**

Attach the cord relief and the cable tie in the bottom of the lower trunk using the countersunk taptite bolt. **NOTE:** Attache the cord relief in the top if the power source is in the celing.

**3**

Pull the cable through the trunk if the power source is in the floor. For power source in the celing, pull the cable straight up from the birdhouse.

**4**

Place the trunk in the foot.

**5**

Grommet

Pull the cable out to the side of the foot. Make sure the grommet is in place, protecting the cable around the exit.

**6**

Fastener Set Screw 6x20

Use the set screws to attach and align the trunk in the foot.

# Assembly Instructions – Leaf Lamp Tree M

Leaf Lamp Series

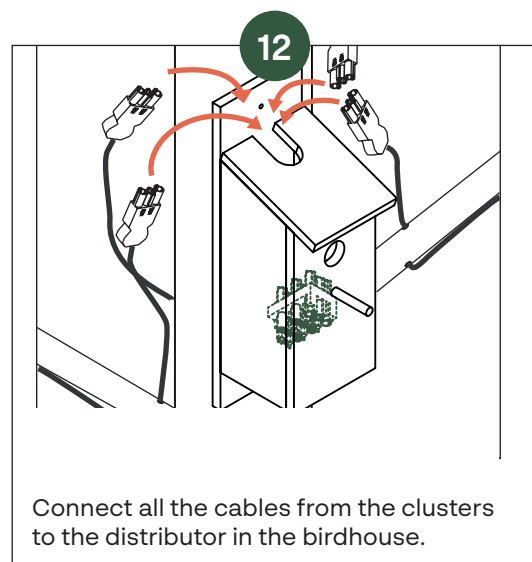
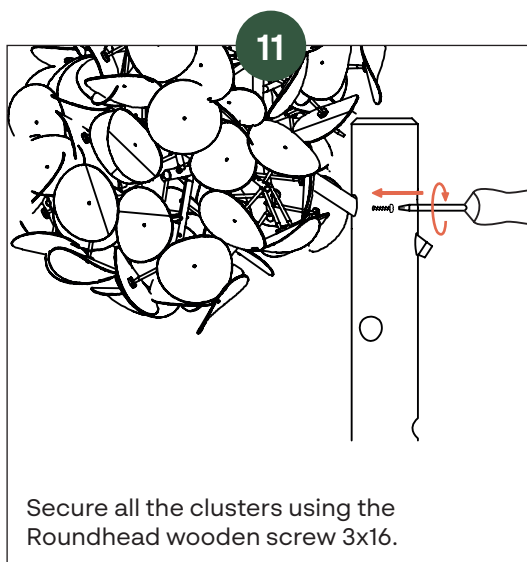
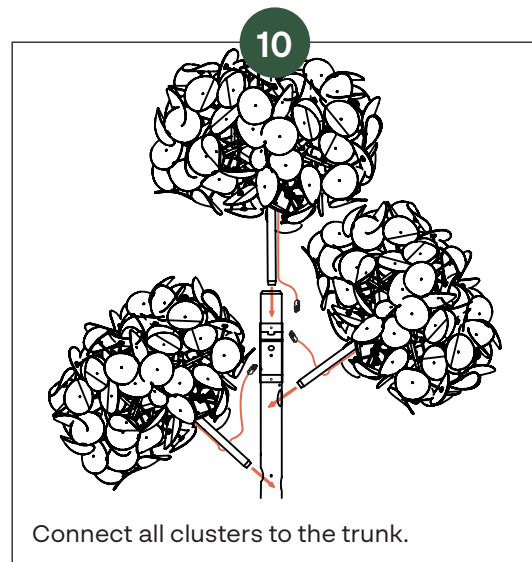
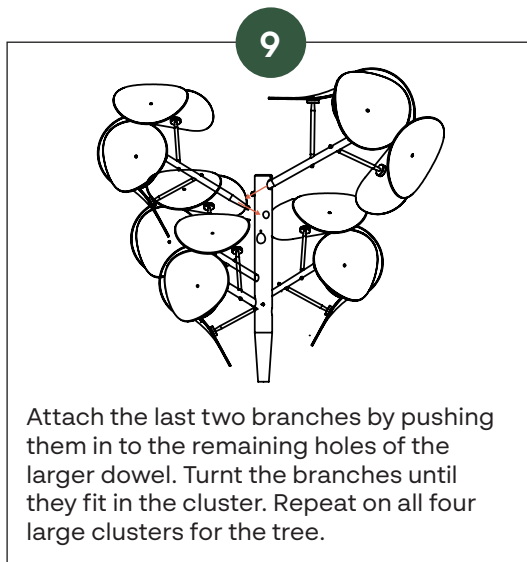
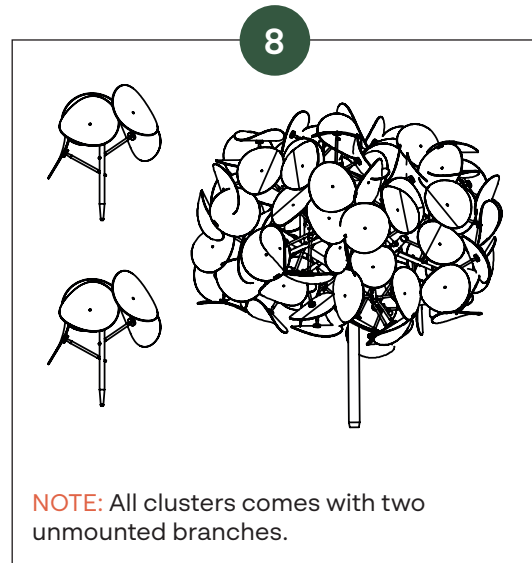
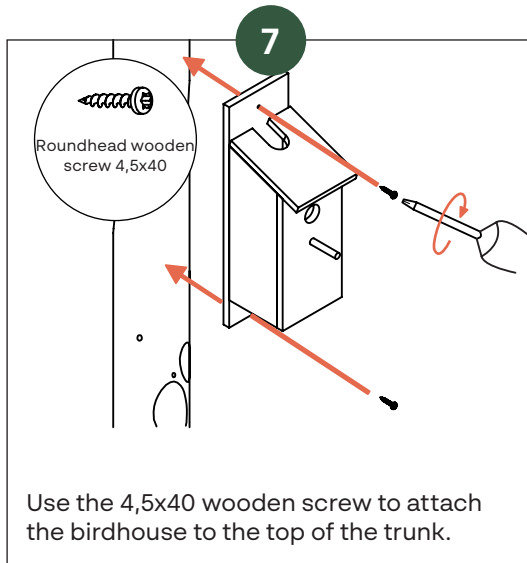



# Assembly Instructions – Leaf Lamp Tree M

Leaf Lamp Series

13



Connect the cable from the power source to the distributor aswell.

14

